

SPECIFICATION	VALUE
NO. of PHASES	3
NO. of POLES	4
RATED VOLTAGE(V)	24
RATED CURRENT(A)	1.09±10%
RATED POWER(W)	20
RATED SPEED(RPM)	3000±10%
RATED TORQUE(mN.m)	64
NO LOAD CURRENT(A)	0.1
NO LOAD SPEED(RPM)	4200
SENSOR	HALL SENSOR
INSULATION CLASS	CLASS B
INSULATION RESISTANCE	100MΩ MIN @ 500VDC
DIELECTRIC STRENGTH TEST	500VAC for 1 MINUTE
BEARING TYPE	NMB BALL BEARING, C3

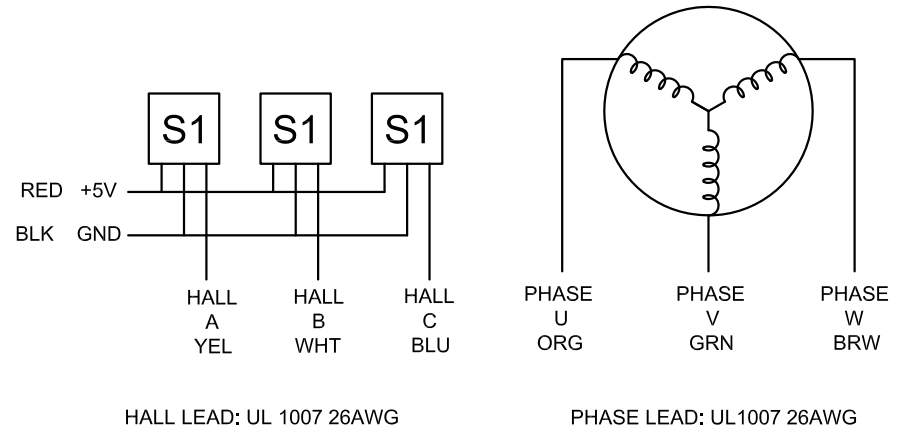

APVD		
CHKD		
1.5:1	DRN	
SCALE	SIGNATURE	DATE

**BRUSHLESS DC MOTOR**

**36BLR65-24-01**