

SPECIFICATION	VALUE
NO. of PHASES	3
NO. of POLES	4
RATED VOLTAGE(V)	12
RATED CURRENT(A)	1.9±10%
RATED POWER(W)	15
RATED SPEED(RPM)	3000±10%
RATED TORQUE(mN.m)	48
NO LOAD CURRENT(A)	0.7
NO LOAD SPEED(RPM)	3800
SENSOR	HALL SENSOR
INSULATION CLASS	CLASS B
INSULATION RESISTANCE	100MΩ MIN @ 500VDC
DIELECTRIC STRENGTH TEST	500VAC for 1 MINUTE
BEARING TYPE	NMB BALL BEARING, C3

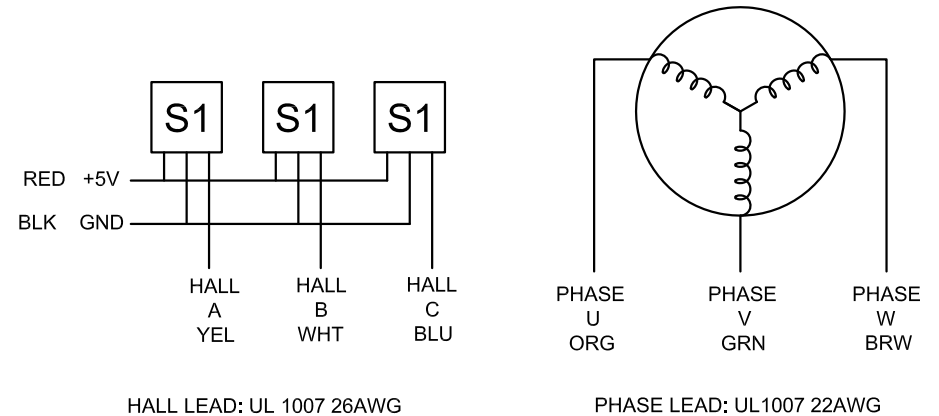

	APVD		
	CHKD		
1.5:1	DRN		
SCALE	SIGNATURE	DATE	

**BRUSHLESS DC MOTOR**

**42BLR53-12-01**